



BOUCHARD COOPERAGES

# OAK PRICING & PORTFOLIO

2024 BRITISH COLUMBIA

Wineglobes / Barrels / Barrel Alternatives / Puncheons / Casks / Ovals



Glass / French Oak / Hungarian Oak / Austrian Oak / American Oak  
Eastern European Oak / French Acacia / Austrian Acacia

*A commitment to quality and customer service since 1979*

WINEGLOBE

DAMY  
MEURSAULT - FRANCE

TONNELLERIE  
*Billon*  
BEAUNE - FRANCE

*maury&fils*  
TONNELLERS A BORDEAUX DEPUIS 1883

CANADELL

FOR THE PLANET  
Master  
Coopers

S  
SCHNECKENLEITNER  
AUSTRIA

EUROPEAN  
HUNGARY  
COOPERS

www.bouchardcooperages.com • (707) 257-3582 • sales@bouchardcooperages.com





Vincent DAMY, Billon manager and 2007 meilleur ouvrier de France.

This unique label ensures a high quality barrel's traceability, drying, technical features and respect for tradition.

Tonnellerie Billon is part of the PEFC (Programme for the Endorsement of Forest Certification) which is the world's largest forest certification system that promotes sustainable forest management.

STYLISTICALLY



BILLON Côte d'Or 228L barrel made 100% oak from Burgundy and "Subtil" steam bending.

HISTORY

Tonnellerie Billon was created in 1947 by Gaston Billon, is located in Beaune and produces premium traditional forest origin barrels, puncheons and casks (225L - 820L) sourced from different French forests.

TODAY

Tonnellerie Billon is managed by Vincent Damy, who was awarded the prestigious "Meilleur Ouvrier de France" in 2007. Tonnellerie Billon along with sister company Tonnellerie Damy form Les Tonnelleries de Bourgogne or translated "The Cooperages of Burgundy", one of the few suppliers still able to offer oak selection by forest origin.

Since 1997 barrels produced at Billon are CTB certified (fûts de traditions Française - traditional French barrels).



Billon Subtil process.

*Billon barrels are most well known for respecting the wine and being true to the varietal by showcasing the fruit on the nose and palate as well as offering tremendous length and enhanced minerality.*

STRONG POINTS

- Forest origin and special barrels
  - Special barrels: Select and Richelieu
- Partnered with stave mill in the Jura region of France:
  - Merrains du Jura
- Independently owned and part of Les Tonnelleries de Bourgogne
- Fire bent or steam bent and fire toasted barrels
- Offers French acacia barrels
- Offers French oak barrels, puncheons and casks (225L - 820L)







Merrains Jura



## 2024 BILLON BRITISH COLUMBIA PRICES

ALL BARRELS FROM BOUCHARD COOPERAGES CAN BE COMBINED FOR VOLUME PRICE DISCOUNTS

Product	Qty	FRENCH OAK		FRENCH ACACIA		225/228L	300L	500L
						+81 €	+91 €	+133 €
Bordeaux Export (225L)	1-10	1,050 €		945 €	<p>A unique blend of oak from small micro climates within three of the finest forests in France. One forest contributes a noted minerality, another imparts structure, texture and spice, while the third brings softness, freshness and elegance.</p> <p>Its proprietary toasting was developed specifically for bolder red varietals and blends.</p> <p>Minimum of 3 year air-dried staves, and 4 year air-dried heads.</p> <p>Available from in all toast levels, from 225L &amp; 228L to 500L</p>			
Burgundy Export (228L)	11-30	1,040 €		935 €				
25/27 mm staves, 6/8 galvanized hoops	31+	1,029 €		926 €				
<b>265L Export</b>						225/228L	300L	500L
Burgundy sized heads and Bordeaux length staves, 25/27 mm staves, 6/8 galvanized hoops	1-10	1,106 €		994 €		+93 €	+109 €	+155 €
	11-30	1,095 €		984 €				
	31+	1,084 €		974 €				
<b>300L Puncheon</b>					<p>Special selection of Extra Tight Grain from a blend of French forests, minimum of 30 months air dry, intended for longer aging. Extended toasting with low flame intensity.</p> <p>Proprietary toast, available from 225L &amp; 228L to 500L</p>	225/228L	300L	500L
25/27 mm staves, 8 galvanized hoops	1-10	1,224 €		1,120 €				
	11-30	1,212 €		1,109 €				
	31+	1,200 €		1,097 €				
<b>350L Puncheon</b>						225/228L	300L	500L
27/29 mm staves, 8 galvanized hoops	1-10	1,375 €		1,221 €		+15 €	+18 €	+30 €
	11-30	1,362 €		1,208 €				
	31+	1,348 €		1,196 €				
<b>400L Puncheon</b>						225/228L	300L	500L
27/29 mm staves, 8 galvanized hoops	1-10	1,621 €		1,504 €		+150 €	+150 €	+150 €
	11-30	1,605 €		1,489 €				
	31+	1,589 €		1,474 €				
<b>500L Puncheon</b>					<p>A 180 minute light long toast on only small embers available on all forests and sizes. This "chauffe à coeur" style toast penetrates the entirety of the stave and resembles a very minimally toasted barrel despite being toasted on small embers for 3 hours. Aimed to offer clarity and purity to the fruit and terroir components of your wine.</p> <p>Proprietary toast, available from 225L &amp; 228L to 820L</p>	225/228L	300L	500L
30/32 mm staves, 8 galvanized hoops	1-10	1,862 €		1,698 €				
	11-30	1,844 €		1,681 €				
	31+	1,825 €		1,664 €				
<b>FRENCH OAK CASKS</b>						228L		+60 €
Product	600L	700L	820L	<p>Only three year air dry oak from Burgundy's Côte D'or department is used to craft this barrel. Therefore 100% Côte D'or Burgundian oak coupled with the *Subtil steam bending process and different choice of toasts caters to an elegant respectful Burgundian barrel for pinot noir and chardonnay.</p>				
32 mm staves, 8 galvanized hoops	1,923 €	2,116 €	2,446 €					
45 mm staves, 8 galvanized hoops	2,369 €	-	-					
<b>BARREL OPTIONS</b>					<b>FOREST ORIGIN</b>		<b>TOAST LEVELS</b>	
Name	200-265L	300-500L	600-820L	Allier	Light			
Head Toasting (All forests)	+10 €	+14 €	+21 €	Vosges	Light Long			
3 Year Air Dry (All forests)	+33 €	+40 €	+52 €	Nevers	Chauffe 180 min			
4 Year Air Dry (Allier, Jura, Vosges)	+47 €	-	-	Jura	Medium			
5 Year Air Dry (Very limited availability)	+57 €	-	-	Chatillon	Medium Long			
Burgundy Batard (4 chestnut hoops)	+22 €	-	-	Eastern European	Medium Plus			
Burgundy Château (8 chestnut hoops)	+44 €	-	-	*Offered at -90€	Heavy			
Black Hoops	+22 €	+57 €	-					

Exclusive forest origins such as Tronçais, Bertranges, Jupilles and Citeaux are available for an additional charge.

3

TONNELLERIE  
*Billon*  
BEAUNE - FRANCE

All prices above are listed in Euros (€), and include customs clearance and delivery to your winery in the Okanagan Valley. Delivery outside the Okanagan Valley may be arranged for an additional charge. Because of freight and port delays, please place your order as early as possible, and by all means before the end of May. Our goal is for the barrels to arrive in Summerland in early-September, but we will ship containers as early as they are filled. Free winery delivery and price discounts are available for full container purchases. Please inquire.

www.bouchardcooperages.com  
sales@bouchardcooperages.com • (707)257-3582



Jérôme Damy, Damy manager and 2007 meilleur ouvrier de France.

**HISTORY**

Tonnellerie Damy is a third generation cooperage located in Meursault, Burgundy that was founded in 1946 by M. Roger Damy and produces premium traditional forest origin barrels, puncheons and casks (225L - 860L) sourced from different French forests.

**TODAY**

Tonnellerie Damy is now managed by Jérôme Damy who, like his father Jacques Damy in 1976, was awarded the Meilleur Ouvrier de France award in 2007. Tonnellerie Damy along with sister company Tonnellerie Billon form Les Tonnelleries de Bourgogne or translated "The Cooperages of Burgundy", one of the few suppliers still able to offer oak selection by forest origin.

Since 1997 barrels produced at Damy are CTB certified (fûts de traditions Française traditional French barrels) which is a unique label, ensuring a high quality barrel's traceability, drying, technical features and respect for tradition.

Tonnellerie Damy is part of the PEFC (Programme for the Endorsement of Forest Certification) which is the world's largest forest certification system that promotes sustainable forest management.

Tonnellerie Damy is one of the most renowned Burgundian Cooperages. The barrels are synonymous with the world's greatest Chardonnays and Pinots and are featured in many Côtes de Beaune and Nuits domaines. The distinctive and delectable house style is the reason you will find Damy barrels in many wineries around the world.

**STYLISTICALLY**

*Damy barrels have traditionally offered a stunning ability to soften tannins and provide a creamy, rounded mid-palate, while its lighter more respectful toasting enhances vineyard terroir. Both styles of toasting support and enhance fruit sweetness to complement both white and red wines, and both are available in a variety of forest origins.*



Noisette color of the inside of a DAMY barrel after the 2 hour super light long "Imperial" toast.

**STRONG POINTS**

- Forest origin and special barrels
  - Special barrels: Rouge, R2, Estrella, Exclusive and Imperial
- Partnered with stave mill in the Jura region of France:
  - Merrains du Jura
- Independently owned and part of Les Tonnelleries de Bourgogne
- Fire bent and fire toasted barrels
- Offers French oak barrels, puncheons and casks (225L - 860L)



New loading dock covering with incorporating solar panels and future green wall.

**IMPERIAL** | Three forest blend, seasoned 36 months, with two hour light long proprietary toast

*Délicat* | Optional barrel finishing technique

- Light Long Plus Plus Toast



## 2024 DAMY BRITISH COLUMBIA PRICES

ALL BARRELS FROM BOUCHARD COOPERAGES CAN BE COMBINED FOR VOLUME PRICE DISCOUNTS

Product	Qty	FRENCH OAK
Bordeaux Export (225L)	1-10	1,050 €
Burgundy Export (228L)	11-30	1,040 €
25/27 mm staves, 6/8 galvanized hoops	31+	1,029 €
<b>265L Export</b>		
Burgundy sized heads and Bordeaux length staves, 25/27 mm staves, 6/8 galvanized hoops	1-10	1,106 €
	11-30	1,095 €
	31+	1,084 €
<b>300L Puncheon</b>		
25/27 mm staves, 8 galvanized hoops	1-10	1,224 €
	11-30	1,212 €
	31+	1,200 €
<b>350L Puncheon</b>		
27/29 mm staves, 8 galvanized hoops	1-10	1,375 €
	11-30	1,362 €
	31+	1,348 €
<b>400L Puncheon</b>		
27/29 mm staves, 8 galvanized hoops	1-10	1,621 €
	11-30	1,605 €
	31+	1,589 €
<b>500L Puncheon</b>		
30/32 mm staves, 8 galvanized hoops	1-10	1,862 €
	11-30	1,844 €
	31+	1,825 €



225/228L	300L	500L
+93 €	+109 €	+155 €

Limited quantities. Created especially for powerful, grand-cru style wines. Extra tight grain from a melange of the finest French forests. Optimal seasoning and proprietary toast. Brings a restrained, fruit-forward elegance.

(Available from 225L & 228L - 500L)



225/228L	300L	500L
+62 €	+72 €	+103 €

A hand-selected blend of extra tight grain French oak all sourced from one long term respected supplier. Damy Rouge 36 months seasoning, R2 24 months. Proprietary Toast. An intense finishing toast is used to help develop structure in bolder red wines. R2 has an even longer toasting, intended for stronger varietals.

(Available from 225L & 228L - 500L)



225/228L	300L	500L
+33 €	+40 €	+40 €

Specifically developed to honor the character of Rhône varietals (red and white). Extra tight grain French oak from a premier French forest and single supplier. 36 months seasoning. Proprietary Toast. Reveals fruity notes and sweetness on the nose; silky smooth tannins on the palate with volume and freshness.

(Available from 225L & 228L - 500L)



225/228L	300L	500L
+15 €	+18 €	+18 €

A proprietary barrel finishing technique unique to Tonnellerie DAMY that aims to soften the initial presence of the oak and elevate the integration and harmony between the fruit, oak and toast. This technique maintains DAMY's signature mid-palate volume and roundness.

(Available from 225L & 228L - 500L)



225/228L	300L	500L
+150 €	N/A	+150 €

A blend of premium oak from the Vosges, Allier and Jura regions of France with a proprietary 2 hour light long toast only on small embers that gives a very light noisette colored toast to the barrel. Aimed to offer very nuanced oak characteristics and lift the terroir and fruit components of your wine.

(Available in 225L, 228L, 500L & 600L)

### TOAST LEVELS

- Light
- Light Long
- Light Long Plus Plus
- Medium
- Medium Long
- Medium Plus
- Heavy

### FRENCH OAK CASKS

Product	600L	700L	860L
32 mm staves, 8 galvanized hoops	1,923 €	2,116 €	2,547 €
45 mm staves, 8 galvanized hoops	2,369 €	2,562 €	2,993 €

### BARREL OPTIONS

Name	200-265L	300-500L	600-820L
Head Toasting (All forests)	+10 €	+14 €	+21 €
3 Year Air Dry (All forests)	+33 €	+40 €	+52 €
4 Year Air Dry (Allier, Jura, Vosges)	+47 €	-	-
5 Year Air Dry (Very limited availability)	+57 €	-	-
Burgundy Batard (4 chestnut hoops)	+22 €	-	-
Burgundy Château (8 chestnut hoops)	+44 €	-	-
Black Hoops	+22 €	+57 €	-

### FOREST ORIGIN

- Allier
  - Vosges
  - Nevers
  - Jura
  - Chatillon
  - Eastern European
- \*Offered at -90€

Exclusive forest origins such as Tronçais, Bertranges, Jupilles and Citeaux are available for an additional charge.

5

**DAMY**  
MEURSAULT - FRANCE

All prices above are listed in Euros (€), and include customs clearance and delivery to your winery in the Okanagan Valley. Delivery outside the Okanagan Valley may be arranged for an additional charge. Because of freight and port delays, please place your order as early as possible, and by all means before the end of May. Our goal is for the barrels to arrive in Summerland in early-September, but we will ship containers as early as they are filled. Free winery delivery and price discounts are available for full container purchases. Please inquire.

www.bouchardcooperages.com  
sales@bouchardcooperages.com • (707)257-3582



## HISTORY

Tonnellerie Maury & Fils is a traditional fourth generation cooperage that originated along the “quai des chartrons quartier” of Bordeaux in 1893. It is in this area of the city along the Garonne river that wine barrels were loaded onto ships and exported to Britain and soon after, around the world.

Tonnellerie Maury specializes in the 225L Bordeaux barrel but also makes sizes up to 500L puncheons based on different oak grain tightnesses originating from different French oak forests from the center of France.

## TODAY

Tonnellerie Maury is now managed by Mathieu Maury who is a fourth generation cooper. Mathieu has a very strong reputation and image in the local Bordeaux market where 90% of his barrels are sold to Grand Cru Classé Châteaux in the region.



Mathieu Maury and barrels toasting at the cooperage in Bordeaux.

Mathieu’s proximity to Bordeaux has allowed the brand to position itself as a preferred partner rather than a mere provider to Bordeaux’s greatest Châteaux.

Tonnellerie Maury is part of the PEFC (Programme for the Endorsement of Forest Certification) which is the world’s largest forest certification system that promotes sustainable forest management.

## STYLISTICALLY

*Maury barrels focus on fruit purity, expression, aromatics and structure. The barrels allow the fruit to remain in focus while providing lift and fullness. They are delicate enough for a lighter vintage but have enough personality and impact to excel in warmer vintages and richer wine styles.*



Finished 225L Bordeaux Château barrel.



Maury MC2 toasted barrels at Château Talbot in St. Julien.

## STRONG POINTS

- Reputation is built on 225L Bordeaux style barrels
- Barrels are categorized on grain tightness and all of the oak comes from the center of France
- Offers barrels made with Limousin open grain oak
- Special Toast,  $mc^2$



- Fire bent and fire toasted barrels
- Offers French oak barrels and puncheons (225L - 500L)

## 2024 MAURY BRITISH COLUMBIA PRICES

ALL BARRELS FROM BOUCHARD COOPERAGES CAN BE COMBINED FOR VOLUME PRICE DISCOUNTS

Product	Qty	FRENCH OAK 24 MONTHS AIR DRY
<b>Bordeaux Export (225L)</b> 25/27 mm staves, 8 galvanized hoops	1-10	1,194 €
	11-30	1,178 €
	31+	1,161 €
<b>Bordeaux Export Thin Stave (225L)</b> 20/22 mm staves, 8 galvanized hoops	1-10	1,208 €
	11-30	1,194 €
	31+	1,175 €
<b>Bordeaux Château Ferré (225L)</b> Barre crossing heads, no chestnut hoops, 22mm staves, 8 galvanized hoops	1-10	1,251 €
	11-30	1,238 €
	31+	1,218 €
<b>Bordeaux Château (225L)</b> Barre crossing heads, chestnut hoops, 22mm staves, 8 galvanized hoops	1-10	1,293 €
	11-30	1,280 €
	31+	1,262 €
<b>265L Export</b> Burgundy sized heads and Bordeaux length staves 25/27mm staves, 8 galvanized hoops	1-10	1,298 €
	11-30	1,282 €
	31+	1,265 €
<b>300L Hogshead</b> 25/27mm staves, 8 galvanized hoops	1-10	1,346 €
	11-30	1,332 €
	31+	1,316 €
<b>350L Hogshead</b> 25/27mm staves, 8 galvanized hoops	1-10	1,434 €
	11-30	1,422 €
	31+	1,408 €
<b>400L Puncheon</b> 25/27mm staves, 8 galvanized hoops	1-5	1,698 €
	6+	1,673 €
<b>500L Puncheon</b> 25/27mm staves, 8 galvanized hoops	1-5	1,985 €
	6+	1,956 €

BARREL OPTIONS	MC <sup>2</sup>	MAURY 130	TOAST LEVELS
<p><b>Name</b></p> <p>3 Year Air Dry +40 €</p> <p>Extra Tight Grain +45 €</p> <p>Head Toasting No Charge</p> <p>Black Hoops +30 €</p> <ul style="list-style-type: none"> <li>600L Demi-Muid available upon request</li> <li>Limousin or open grain French oak for spirits and wine available upon request</li> </ul>	 <p>A unique extended light long double toasting technique that caters to an elegant and fresh expression of the varietal and promotes the vineyard's typicities and complexities.</p> <p>(Available on all barrel sizes)</p> <p>+40 €</p>	<p>In homage to 130 years of Tonnellerie MAURY, the MAURY 130 are hand-scraped Bordeaux Export barrels made of a premium and optimally seasoned French oak blend with the MC2 toast. Only 130 barrels are available per year.</p> <p>+1,425 €</p>	<ul style="list-style-type: none"> <li>Medium</li> <li>Medium Long</li> <li>Medium Plus</li> </ul>

7



All prices above are listed in Euros (€), and include customs clearance and delivery to your winery in the Okanagan Valley. Delivery outside the Okanagan Valley may be arranged for an additional charge. Because of freight and port delays, please place your order as early as possible, and by all means before the end of May. Our goal is for the barrels to arrive in Summerland in early-September, but we will ship containers as early as they are filled. Free winery delivery and price discounts are available for full container purchases. Please inquire.

www.bouchardcooperages.com  
sales@bouchardcooperages.com • (707)257-3582

## WINEGLOBE: Glass Globes for Winemaking



Meursault 1er Cru Charmes and 1er Cru Genevrières at Domaine Michelot in Meursault in Wineglobes.

Wineglobe, produced in Bordeaux France by the Paetzold family are single piece glass globes that range from 25L – 400L. The most popular sizes are the 115L and 220L which allow for the purest expression regarding terroir-driven wines. The Wineglobe was created in 2015 and in 2020 received the famous Vinitex Innovation Trophy award. Today, it represents the ultimate reference for a neutral, high end cutting edge vessel found in the most prestigious of cellars for the fermentation and aging of white and rosé wines and the aging of red wines.

### MATERIAL

Borosilicate glass is used for making Wineglobes. It is the purest, strongest, and most resistant type of glass allowing for the globes to be inert, smooth, impermeable, neutral, and unaltered over time. Glass is an eternal, noble, and long-lasting material that has a thermal conductivity close to that of concrete, allowing for good temperature stability. The transparency of glass allows lees sedimentation, wine turbidity and malolactic fermentation to be observed and studied.

### HISTORY

In 2010, Institute of Bordeaux graduate, consultant, company founder and estate owner Michael Paetzold initiated research for new containers to be used at his winery in South West France. In 2014, especially with Burgundy domaines including Meursault's Eduard Ente, Paetzold started seriously looking into glass as an aging vessel since winemakers always loved the wines aged their "demijannes". The Wineglobe came to be in 2015 and was tested through 2019 on all varietals. In 2020, the first Wineglobes were commercially sold. Today, over 500 customers are using Wineglobes in some the most famous cellars in France and worldwide.

### PRODUCTION

Wineglobes are produced at an onsite custom state of the art glass oven in Bordeaux where the quality of the craftsmanship is second to none. Unique about Wineglobes is how they are made from a single piece of glass and possess extremely winemaker friendly accessories.



Line of Wineglobes on Wave stand at Chateau Grand Corbin in Saint Émilion.

### POROSITY

The porosity on Wineglobes is 0% making them oxygen proof however their shape allows for the wine to stay in constant motion, be dynamic and alive and avoid being reduced.

### WINEMAKING & STYLES OF WINE

Wineglobes have been shown to produce unique wines that are totally different to those fermented and aged in wood, concrete or steel vats. The natural features of the fruit, vineyard, and terroir are exposed in a way that is completely distinctive, unique and produces wines of purity and perfume. Wineglobes represent a unique tool to understand your terroir, vineyard and fruit in their purest forms and can be used interchangeably on all styles of white, rosé, sparkling base, skin contact or red wines. Due to the elimination of headspace, topping is not needed and SO<sub>2</sub> additions can be reduced by 25% to 50%.







Wineglobes with the design stand at François Chidaine in the Loire.



# 2024 WINEGLOBE BRITISH COLUMBIA PRICES

ALL BARRELS FROM BOUCHARD COOPERAGES CAN BE COMBINED FOR VOLUME PRICE DISCOUNTS

THE GLOBE	115L	INCLUDED ACCESSORIES (115L/220L)
 <ul style="list-style-type: none"> <li>Maximum operating pressure allowance is 0.1bar</li> <li>The Globe is resistant to thermal shock (heating and rapid cooling) up to 194°F</li> </ul>	<b>VOLUME (GAL)</b> 30 <b>WEIGHT (LBS)</b> 45 <b>HEIGHT (IN)</b> 29 <b>DIAMETER (IN)</b> 24 <b>PRICE</b> 2,990 €	 <p><b>THE LID</b> Designed for filling to the brim (like barrels) Composed of: - 1 316L stainless steel cover, brushed - 6 black or white brackets - 1 L seal - BNIC et FDA - 1 Silicone bung + 1 plastic bubbler</p>
	<b>VOLUME (GAL)</b> 58 <b>WEIGHT (LBS)</b> 75 <b>HEIGHT (IN)</b> 36 <b>DIAMETER (IN)</b> 30 <b>PRICE</b> 5,490 €	 <p><b>THE TEFLONE CROSS STAND</b> Material: food-grade teflon Color: black or white L 430 x I 430 x H 120 mm Thickness: 30 mm</p>
		 <p><b>DARK SLIPCOVER</b> Efficiently protects the Wineglobe from light Easy to slip on/off with the lid in place Material: Lyrca</p>

## OPTIONAL ACCESSORIES FOR 220L (ADDITIONAL ACCESSORIES AVAILABLE UPON REQUEST)

THE WOODEN CROSS STAND 90 €	STAINLESS STEEL SQUARE 975 €	THE OAK TIN STAND 1,500 €	THE DESIGN STAND 875 €	THE WAVE STAND 875 €
 <p>Material: oak L 380 x I 390 x H 102 mm Thickness: 30 mm</p>	 <p>Allows to move full Wineglobe by forklift or pallet jack. Material: 316L stainless steel L 780 x I 780 x H 200 mm</p>	 <p>Material: untreated oak Length: 1600 mm</p>	 <p>Material: 316L stainless steel, brushed finish L 810 x I 702 x H 398 mm</p>	 <p>Material: 316L stainless steel, brushed finish L 810 x I 702 x H 398 mm</p>
THE HARNESS 330 €	THE WASHING STAND 1,500 €	THE LEES STIRRER 275 €	THE GLASS BUBBLER 240 €	LID CUSTOMIZATION 185 €
 <p>Designed for manual handling of the empty Wineglobe. Ideal for moving, turning upside down, drying out the Wineglobe. Material: fabric</p>	 <p>Ideal for gathering lees, washing and drying out the Wineglobe. Material: 316L stainless steel, brushed finish, with anti-scratch pads H 718 - Ø 930 mm</p>	 <p>Ideal to realize the operation of batonnage in Wineglobe. Material: 316L stainless steel rod and food grade teflon stirrer Length: 1300 mm</p>	 <p>Siphon system for silicon bung drilling drilling Ø32 cm. Designed to see the wine inside and take samples with a pipetter through the glass tube. Material: borosilicate glass 3.3</p>	 <p>Possibility to have your logo engraved on the cover. Engraving Color: Black</p>



Master Cooper Kristof selecting oak trees in the Tokay forest for stave production.

European Coopers Hungary produces premium Hungarian oak barrels that are everything you would expect from a quality-driven artisan cooper.

Kristof and his team control the entire process in house, from sourcing and selecting 100% Hungarian logs from Hungary's best forests in the Zemplen and Mecsek hills, to seasoning the staves, and producing and finishing the barrels.

### STYLISTICALLY

*European Coopers Hungary barrels are either coopered exclusively with oak from the forests of Tokay, Mecsek or a blend of both forests. Tokay offers elegance and a fine tannin profile while Mecsek offers phenolic richness and palate weight.*



Rows of European Coopers Hungary barrels being used to age Tignanello at Antinori's Bargino winery.

### HISTORY

European Coopers Hungary is a premium Hungarian cooperage that produces Hungarian oak barrels (225L - 500L). The cooperage is located two hours south of Budapest and is proud of remaining independent since its establishment in 1997. With over forty years of experience, Master Cooper Kristof Flodung has been at the heart of European Coopers Hungary since day one in 1997.

### TODAY

European Coopers Hungary was co-founded by three respected Italian winemaking families that were searching for premium Hungarian oak for their wines. Vincent Bouchard is involved as a consultant on toasting and barrel technicalities.

After opening its markets and becoming part of the EU in 2004, there has been a resurgence in demand for Hungarian oak on the international wine scene.



Master Cooper Kristof between his signature Kristof barrel and a European Coopers Hungary barrel.

### STRONG POINTS

- Hungarian oak barrels and a special barrel
  - Special barrel: Kristof
  - Special Toast: Radiant White and Radiant Red
- The sourcing, cutting, splitting and ageing of the wood and coopering of the barrel is all done internally
- Independently owned cooperage
- Only 3-Year air dried oak
- Fire bent and fire and convection toasted barrels
- European Coopers Hungary purchases logs from parts of the Mecsek and Tokay forests that have the FSC certificate and the Natura 2000 certificate which both promote sustainable forest management
- Offers Hungarian oak barrels and puncheons (225L - 500L)



## 2024 EUROPEAN COOPERS BRITISH COLUMBIA PRICES

ALL BARRELS FROM BOUCHARD COOPERAGES CAN BE COMBINED FOR VOLUME PRICE DISCOUNTS

Product	Qty	HUNGARIAN OAK 36 MONTHS AIR DRY			
Bordeaux Export (225L)	1-10	741 €		Bordeaux Château (225L) +60 € 4 chestnut hoops, barre crossing heads, 20/22 mm staves, 6/8 galvanized hoops	
	11-30	729 €			
Burgundy Export (228L)	31-67	721 €			
25/27 mm staves, 6/8 galvanized hoops	68-1C	711 €			
	1-10	712 €		Bordeaux Château Ferré (225L) +30 € Barre crossing heads, no chestnut hoops 20/22 mm staves, 6/8 galvanized hoops	
Bordeaux Export Thin Stave (225L)	11-30	697 €			
	31-67	690 €			
20/22 mm staves, 6/8 galvanized hoops	68-1C	679 €			
265L Export	1-10	808 €		 +50 €	
Burgundy sized heads and Bordeaux	11-30	795 €			
length staves, 25/27 mm staves, 6/8	31-50	787 €			
galvanized hoops	51-1C	768 €			
	1-10	851 €		Named for Master Cooper Kristof Flodung, the Kristof barrel is a blend of extra tight grain from the finest selections of Tokay. The staves are aged for a minimum of 3 years and the heads 4-5 years. All toasting options are finished with a proprietary process developed for deeper penetration, subtlety and elegance.  (Available from 225L & 228L - 500L)	
300L Hogshead	11-30	842 €			
	31-50	834 €			
25/27 mm staves, 6/8 galvanized hoops	51-1C	820 €			
	1-10	919 €			
350L Puncheon	11-25	909 €			
	26-45	901 €			
27 mm staves, 8 galvanized hoops	46-1C	894 €			
	1-8	1,072 €			
400L Puncheon	9-16	1,058 €			
	17-25	1,052 €			
27 mm staves, 8 galvanized hoops	26-1C	1,041 €			
	1-8	1,273 €			
500L Puncheon	9-16	1,256 €			
	17-25	1,250 €			
27 mm staves, 8 galvanized hoops	26-1C	1,243 €			
OAK SELECTIONS				SPECIAL SIZES	
Name	Forest Origin	Grain Width	Air Dry	Size	Price
Tokay	Tokay Mountains	< 1.5 mm	36 months	60L	351 €
Tokay Blend	2/3 Tokay, 1/3 Mecsek	1.5-2.0 mm	36 months		
Hungarian	Blend of Tokay and Mecsek	1.5-3.0mm	36 months	110L	454 €
Mecsek Blend	1/3 Tokay, 2/3 Mecsek	2.0-3.0 mm	36 months		
Mecsek	Mecsek Hills	2.0-3.0 mm	36 months	600L	1,403 €
BARREL OPTIONS			TOAST LEVELS		
Name	200-265L	300-500L	Fire Toast		Convection Toast
Head Toasting	+10 €	+13 €	■ Light	■ Medium Plus	■ Radiant White
Tokay Oak (extra fine grain)	+27 €	+47 €	■ Light Long	■ Heavy	■ Radiant Red
2/3 Tokay Oak Selection	+13 €	+23 €	■ Medium		
			■ Medium Long		



# MASTER COOPERS

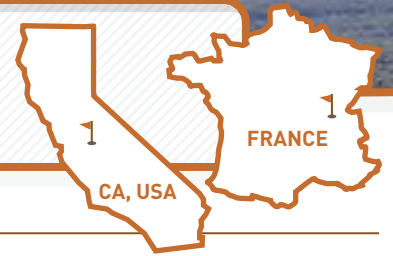

## HISTORY

After 36 years of passion and dedication to the cooperage business, Vincent Bouchard created his own unique recipe for American Oak barrels.

Master Coopers strives for the integration of wood and wine throughout the 5 stages of tasting: the nose, the front palette, the mid palette, the finish and what in Italy is called the "retro-gusto" where the wine comes back after drinking or spitting. The integration is balanced in a way that shows a reverence for fruit and terroir.

What distinguishes the Master Coopers brand is the unique proprietary way the barrels are toasted. The proprietary toasting process is much longer than the traditional toasting time and done at a lower flame, designed to optimize the essence of American oak while minimizing its undesirable characteristics. That means more subtle oak nuances that lift the fruit and broaden the palate; and less aggressive lactones with no overt oakiness, plankyness or dill.



Vincent Bouchard.

## 1% FOR THE PLANET

One Percent for the Planet is an international organization whose members contribute at least one percent of their annual sales to environmental causes. Master Coopers is a proud member of this program, and the support its barrel sales provides. One Percent for the Planet members assist nonprofit organizations that protect land, forests, rivers, oceans and also encourage sustainable methods of energy production.

## STYLISTICALLY

*Proprietary toast deepens and enhances finesse, elegance and length on French oak and decreases presence of whiskey lactones on American oak.*

## PRODUIT DE BOURGOGNE

Working closely with a selected Burgundian Cooper with whom he has had the longest relationship, the barrels feature 100% 3-year air dry French oak from specially selected premier forests, and are available in both Slow Blue and Slow Red toasts:

- Slow Blue for Chardonnay and other whites
- Slow Red for Pinot Noir and other delicate/aromatic reds.



Master Coopers USA steam bent barrel.

## STRONG POINTS

- Proprietary toast for wines and different char levels for spirits
- Special Barrel: Unity
- Blending of different French forests for the Slow Red and Slow Blue French oak barrels
- State specific forests used for American oak barrels:
  - Minnesota
  - Missouri
- Available in 225L or 228L
- Fire & steam bent barrels
- 3-year air dry and tight grain available upon request
- Master Coopers USA is proud to be partnered with 1% for the Planet



Master Coopers premium "Unity" American oak barrel ready to be filled.



*Made in America*

		ORDER BY MARCH 15	ORDER AFTER MARCH 15
<b>Burgundy Export (228L)</b> 25/27 mm staves, 6 galvanized hoops	1-10	\$ 570	\$ 590
	11-30	\$ 560	\$ 580
	31+	\$ 550	\$ 570
<b>Bordeaux Export (225L)</b> 25/27 mm staves, 6 galvanized hoops	1-10	\$ 570	\$ 590
	11-30	\$ 560	\$ 580
	31+	\$ 550	\$ 570
<b>Bordeaux Export Thin Stave (225L)</b> 20/22 mm staves, 6 galvanized hoops	1-10	\$ 580	\$ 600
	11-30	\$ 570	\$ 590
	31+	\$ 560	\$ 580



\$645

The Unity barrel is a fine selection of tight grain Missouri and Minnesota oak that has been naturally aged in the elements between three to four years with four year air dry heads and a proprietary steam bending and toasting technique that aims to showcase the most subtle nuances of fine American oak to elevate your wine.

BARREL OPTIONS	OAK SELECTIONS	PROPRIETARY TOAST FOR WINE
<p><b>Name</b></p> <hr/> <p>Toasted Heads (TH) No Charge</p> <p>Steam Bending (SB) +\$17</p> <p>3-Year Air Dry (3Y) +\$33</p> <p>Tight Grain Missouri Oak (TG) +\$30</p> <p>Extra-Tight Grain Minnesota Oak (ETG) +\$30</p>	<p>Slow-growth American white oak of the highest quality is seasoned for a minimum of 2 years and sourced from:</p> <p><b>Missouri</b> Missouri oak offers sweetness and vanillia notes.</p> <p><b>Minnesota</b> Minnesota oak is the tightest grained, providing elegance and depth.</p>	<p>The proprietary toasting process, developed personally by Vincent Bouchard, is much longer than the traditional toasting time and done with a lower flame, designed to optimize the essence of American oak while minimizing any undesirable characteristics.</p> <p>That means more subtle oak nuances that lift the fruit and broaden the palate and less aggressive lactones with no overt oakiness, plankiness or dill. Heads are toasted.</p>
		<p><b>TOAST OPTIONS FOR SPIRITS</b></p> <ul style="list-style-type: none"> <li>■ Char 1 - Darkened</li> <li>■ Char 2 - M+ Char</li> <li>■ Char 3 - Heavy Char (Industry Standard)</li> <li>■ Char 4 - Alligator Skin Char</li> </ul>

- The prices above are listed in USD (\$) and include delivery to our Napa Valley, CA warehouse.
- March 15 prices require delivery acceptance as early as June 1.

*Produit de Bourgogne*  
*Made in Burgundy, France.*

Product	Qty	FRENCH OAK			TOAST LEVEL
		MARCH 15	APRIL 15	LATE ORDER	
<b>Burgundy Export (228L)</b> 25/27 mm staves, 8 galvanized hoops	1-15	1,109 €	1,172 €	1,237 €	<ul style="list-style-type: none"> <li>■ Slow Blue Medium</li> <li>■ Slow Blue Medium Long</li> <li>■ Slow Red Medium Long</li> <li>■ Slow Red Medium Plus</li> </ul>
	16-50	1,098 €	1,161 €	1,226 €	
	51-75	1,087 €	1,150 €	1,215 €	
	76-1C	1,082 €	1,145 €	1,210 €	

- March 15 and April 15 prices require delivery acceptance as early as June 1 and July 1 respectively.
- All prices above are listed in Euros (€) and include delivery to either of our distribution warehouses.





SCHNECKENLEITNER  
AUSTRIA

# FASSBINDEREI SCHNECKENLEITNER

1  
AUSTRIA



Paul Schneckenleitner working on a Round.

## HISTORY

Fassbinderei Schneckenleitner is a fifth generation Austrian artisan family run cooperage that is located in Waidhofen/Ybbs, located in the foothills of the Austrian Alps. The cooperage was founded in 1628 and the Schneckenleitner family has been at the helm of the cooperage since 1880. Schneckenleitner produces premium quality puncheons and large format vessels and they are best known for their ovals and casks or rounds as they call them. The oak for these ovals and rounds (10 HL - 60 HL) are sourced 100% from Austrian Oak. However, the cooperage is also recently offering more Austrian Acacia, especially for aromatic whites.

## TODAY

Fassbinderei Schneckenleitner is managed by Paul Schneckenleitner, who is a fifth generation Master Cooper from the Schneckenleitner family. Before managing the family cooperage, Paul gained invaluable experience by working in several Burgundy and Cognac based cooperages.

Schneckenleitner buys entire oak and acacia logs from forests they have been working with for generations. The logs are brought to their production site and the splitting, preparing and air drying of the wood is done on site. They cooper vessels made from tight grain Weidling Oak and Acacia that is sourced from forests in southern Austria.

## STYLISTICALLY

*Schneckenleitner has built their reputation on the production of their large format ovals and puncheons which are found in many of Europe's finest cellars. Because of the large format, the incredibly long and low toast, and significantly long air-drying time results in extremely low impact ovals, rounds and puncheons that respect the wine's fruit, freshness and minerality, while allowing for some natural micro-oxidation to occur. Their large format vessels work both on white and red wines.*



The Schneckenleitner stave mill where logs are received.



The new facade of the cooperage and Paul Schneckenleitner with his sons.



Schneckenleitner casks including 500L 45 mm puncheons.



50 HL conical operating tanks.



Final touches on an Oval.

## STRONG POINTS

- Independently family-owned artisanal cooper where all important steps are still done by hand
- Reputation built on 10HL - 60HL+ Ovals and Rounds
- Also coopers 45 mm thick stave puncheons and conicals
- Directly buys and handles logs at stave mill located at the cooperage
- Air drying of oak is done on site
- Selection of 100% Austrian Oak and Austrian Acacia
- Long air drying time for wood preparation
- House toasts are the: AOC (Austrian Oak Complex) and AOE (Austrian Oak Elegance)

## 2024 SCHNECKENLEITNER BRITISH COLUMBIA PRICES

### PUNCHEONS

Product	500L WEIDLING	500L ACACIA	600L WEIDLING	600L ACACIA	700L WEIDLING	700L ACACIA	800L WEIDLING	800L ACACIA
29 mm thick Staves	1,885 €	1,829 €	2,210 €	2,144 €	2,635 €	2,556 €	3,045 €	2,954 €
45 mm thick Staves	2,350 €	2,230 €	2,830 €	2,745 €	3,260 €	3,162 €	3,620 €	3,511 €

### ROUNDS

Product	LITERS (L)	GALLON (G)	BILGE HEIGHT (IN)	BILGE DIAMETER (IN)	HEAD HEIGHT (IN)	HEAD DIAMETER (IN)	LENGTH OF STAVES (IN)	STAVE THICKNESS (MM)	AUSTRIAN ACACIA	WEIDLING OAK
10HL	1,000	264	49.2	49.2	47	47	51.2	47	11,465 €	11,630 €
13HL	1,300	343	53.5	53.5	47	47	54.7	47	12,985 €	13,195 €
15HL	1,500	396	55.1	55.1	50	50	59.1	50	13,935 €	14,175 €
20HL	2,000	528	60.6	60.6	52	52	63.4	52	16,320 €	16,630 €
25HL	2,500	660	65.7	65.7	57	57	68	57	18,950 €	19,335 €
30HL	3,000	793	69.6	69.6	70	60	72	60	21,275 €	21,745 €

### OVALS

10HL	1,000	264	57.8	41.7	53.1	48	51.2	48	11,670 €	11,835 €
12.5HL	1,250	330	61	43.3	56.3	48	53.5	48	12,895 €	13,095 €
15HL	1,500	396	66	46.8	62.2	50	55.5	50	14,200 €	14,440 €
20HL	2,000	528	74	50.7	68.9	53	60.2	53	16,790 €	17,105 €
25HL	2,500	660	80.3	56.3	74.4	55	62.2	55	19,235 €	19,620 €
30HL	3,000	793	84.3	58.3	78	57	67.7	57	21,835 €	22,305 €

### OVAL WITH STANDARD ACCESSORIES

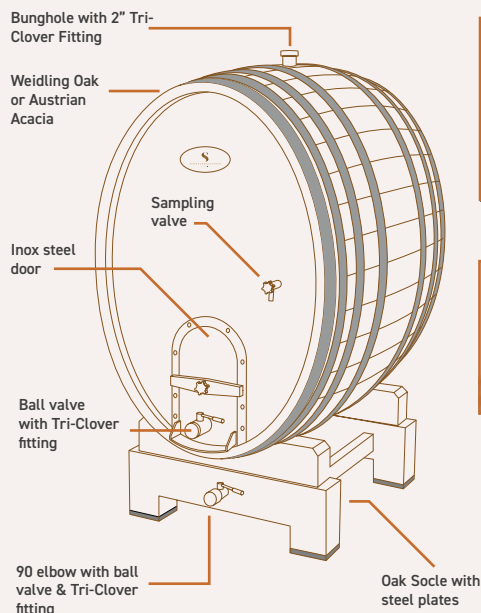

- Oval vertical/horizontal door available upon request.
- Partial or full discharge valves, sample port and manhole available on 5, 6, 7 or 8 HL casks. Available on request.
- Additional sizes up to 60HL available on request, as well as conical upright tanks for aging and maturation.

### CASK & OVAL OPTIONS

#### 500L - 800L OPTIONS

Outlet Connection 1" with Cap	143 €
2" Tri Clover racking ball valve on head	293 €
90 degree elbow drain with 2" Tri Clover butterfly valve	756 €
Wooden Socle	510 €

#### 10HL - 60HL OPTIONS

Top Manhole with TC fitting and pressure compensating valve	Varies on size
Painted Hoops	Varies on size
Cooling Plate	Varies on size
Colmatore	188 €
Laser Engraving	435 €
Thermometer with immersion sleeve	390 €
Thermowell	225 €
1x Oak Support Bar on Head	595 €
2x Oak Support Bar on Head	1050 €

### OAK SELECTIONS

- Weidling Oak**  
Selection of fine grain oak from a forest in Southern Austria.
- Austrian Acacia**  
Selection of Acacia sourced from Southern Austria.

### TOAST LEVELS

Intended for whites or light reds.

AOE - / AOE / AOE+

Intended for rich whites or bold reds.

AOC - / AOC / AOC+



# CANADELL

## CANADELL

FRANCE

1



Fred and Jacques Canadell in front of a French oak log destined for stave production.

With two stave mills in France and connections to France's most prestigious forests, Canadell uses strict proprietary toasting regimens to carefully craft a complete line of oak alternatives.

Canadell oversees the entire manufacturing process of its oak alternative products for full traceability, from selecting trees in the forest to seasoning, splitting, air drying, toasting and the final packaging of the product. Canadell is part of the PEFC (Programme for the Endorsement of Forest Certification) which is the world's largest forest certification system that promotes sustainable forest management and a proud sponsor of the "ONF - AGIR" fund (Office National des Forêts - React) which is committed to the preservation of France's forests to ensure their sustainability and help mitigate the negative impacts of climate change.

### STYLISTICALLY

*The Canadell product line includes powder and chips for use during fermentation and post ferment aging, to dominoes and staves, which best showcase the qualities of French oak and show characters remarkably similar to barrel aging. Canadell bridges the gap between barrels and oak alternatives.*



French oak tree in the Tronçais forest of France.



Oak chips



French oak dominoes



Barrel inserts through the bung



Fire toasted French oak staves



French oak staves

### STRONG POINTS

- Company historically is a merrandier, ensuring control of its oak alternative product line from the source: the oak tree
- Complete in house integration from when oak is cut to packaging
- Family owned and operated
- Large selection of alternative products and toast levels
- Staves are evenly spaced and air dried outside in the elements for optimal ventilation and seasoning
- Fire toasted and convection toasted staves
- Chips • Dominoes
- Barrel and bung inserts





## 2024 CANADELL BRITISH COLUMBIA PRICES

FRENCH OAK TANK STAVES			< 1 PALLET	1 PALLET	2-5 PALLETS	6+ PALLETS
<b>Standard Staves</b> 23.5 ft <sup>2</sup> per fan 20 staves per fan 2 fans per bag 120 bags per pallet	<b>Toasted (L, M, M+)</b>	Per bag	\$231.00	\$225.00	\$223.00	\$221.00
		Per fan	\$115.50	\$112.50	\$111.50	\$110.50
	<b>Long Toast</b>	Per bag	\$250.00	\$244.00	\$242.00	\$237.00
		Per fan	\$125.00	\$122.00	\$121.00	\$118.50
	<b>Fire Toasted</b>	Per bag	\$356.00	\$350.00	\$343.00	\$337.00
		Per fan	\$178.00	\$175.00	\$171.50	\$168.50
<b>Thick Staves</b> 13.7 ft <sup>2</sup> per fan 10 staves per fan 20 staves per bag 100 bags per pallet	<b>Toasted (L, M, M+)</b>	Per bag	\$275.00	\$268.00	\$266.00	\$263.00
		Per fan	\$137.50	\$134.00	\$133.00	\$131.50
	<b>Long Toast</b>	Per bag	\$283.00	\$276.00	\$274.00	\$271.00
		Per fan	\$141.50	\$138.00	\$137.00	\$135.50
	<b>Fire Toasted</b>	Per bag	\$331.00	\$324.00	\$322.00	\$319.00
		Per fan	\$165.50	\$162.00	\$161.00	\$159.50
FRENCH OAK BARREL INSERTS			< 1 PALLET	1 PALLET	2-5 PALLETS	6+ PALLETS
<b>Through the Head</b> 11.8 ft <sup>2</sup> each Sold individually 20 half-staves per system (installation not included)	<b>Toasted (L, M, M+)</b>	Per insert	\$99.00	\$98.00	\$96.00	\$92.00
	<b>Long Toast</b>	Per insert	\$106.00	\$104.00	\$102.00	\$99.00
	<b>Fire Toasted (M, M+)</b>	Per insert	\$129.00	\$128.00	\$124.00	\$119.00
<b>Through the Bung</b> 3.5 ft <sup>2</sup> each Sold individually 3x8 pieces (25 cm x 2.5 cm x 0.7 cm) Oak chain inserted through bung	<b>Toasted (M, M+)</b>	Per insert	\$136.00	\$131.00	\$126.00	\$121.00
	<b>Long Toast</b>	Per insert	\$147.00	\$142.00	\$136.00	\$131.00
	<b>Fire Toasted (M, M+)</b>	Per insert	\$178.00	\$173.00	\$168.00	\$162.00
FRENCH OAK SEGMENTS (DOMINOES)			< 1 PALLET	1 PALLET	2-5 PALLETS	6+ PALLETS
<b>French Oak Segment (Dominoes)</b> 6.4 in <sup>2</sup> each 22 lbs per bag 60 bags per pallet	<b>Toasted (L, M, M+)</b>	Per bag	\$221.00	\$214.00	\$212.00	\$209.00
		Per lb	\$10.05	\$9.73	\$9.64	\$9.50
	<b>Long Toast</b>	Per bag	\$246.00	\$239.00	\$235.00	\$234.00
		Per lb	\$11.18	\$10.86	\$10.68	\$10.64
FRENCH OAK CHIPS			< 1 PALLET	1 PALLET	2-5 PALLETS	6+ PALLETS
<b>French Oak CHIPS</b> 22 lbs per bag 60 bags per pallet	<b>Toasted (L, M, M+, M++)</b>	Per bag	\$102.00	\$99.00	\$95.00	\$92.00
		Per lb	\$4.64	\$4.50	\$4.32	\$4.18
	<b>Long Toast</b>	Per bag	\$113.00	\$108.00	\$105.00	\$103.00
		Per lb	\$5.14	\$4.91	\$4.77	\$4.68
<b>French Oak CHIPS HIGH IMPACT</b> Made from Toasted Staves 22 lbs per bag 60 bags per pallet	<b>Fresh / Untoasted</b>	Per bag	\$97.00	\$92.00	\$90.00	\$87.00
		Per lb	\$4.41	\$4.18	\$4.09	\$3.96
	<b>Toasted (L, M, M+)</b>	Per bag	\$102.00	\$99.00	\$95.00	\$92.00
		Per lb	\$4.64	\$4.50	\$4.32	\$4.18
<b>French Oak CHIPS MATRIX</b> Proprietary Blend of Chips & Mini-Chips / 22 lbs per bag / 60 bags per pallet	<b>Toasted (L, M, M+)</b>	Per bag	\$103.00	\$100.00	\$97.00	\$93.00
		Per lb	\$4.68	\$4.55	\$4.41	\$4.23
	<b>Fresh / Untoasted</b>	Per bag	\$99.00	\$93.00	\$91.00	\$89.00
		Per lb	\$4.50	\$4.23	\$4.14	\$4.05
<b>French Oak MINI-CHIPS</b> 22 lbs per bag 60 bags per pallet	<b>Toasted (L, M, M+)</b>	Per bag	\$103.00	\$100.00	\$97.00	\$93.00
		Per lb	\$4.68	\$4.55	\$4.41	\$4.23
	<b>Fresh / Untoasted</b>	Per bag	\$99.00	\$93.00	\$91.00	\$89.00
		Per lb	\$4.50	\$4.23	\$4.14	\$4.05

- 100% recyclable and biodegradable packaging.
- All Canadell products can be combined for volume price discounts.
- Bulk pricing available upon request.



# FOREST ORIGINS

## FRENCH FORESTS

1. **Jupilles/Bercé** 5,400 ha
2. **Bellême** 2,400 ha
3. **Blois** 2,800 ha
4. **Limousin** 568,000 ha
5. **Allier** 122,000 ha
6. **Tronçais** 10,500 ha
7. **Fontainebleau** 17,000 ha
8. **Nevers** 225,000 ha
9. **Bertranges** 10,000 ha
10. **Ardennes** 36,140 ha
11. **Chatillon** 9,000 ha
12. **Cîteaux** 13,284 ha
13. **Vosges** 280,000 ha
14. **Jura** 180,000 ha

\*ha = generalized hectares of forest that includes other trees besides oak.



\*This custom graphic is property of Bouchard Cooperages.



# FUTAIE GROWTH MAP

## OAK TREE CATEGORIES AND LIFE STAGES

\*This custom graphic is property of Bouchard Cooperages.

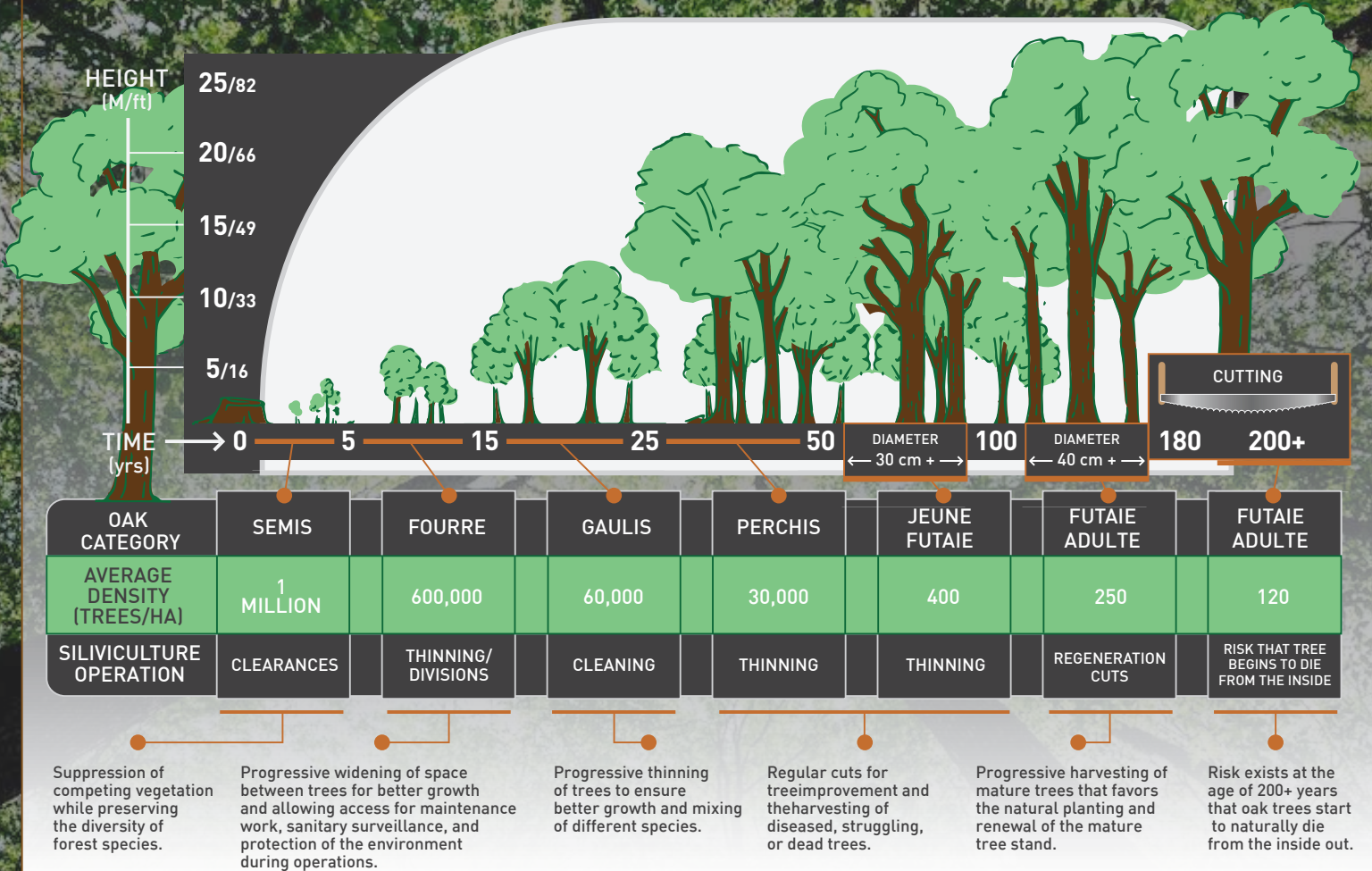



BOUCHARD COOPERAGES

TONNELLERIE  
*Billon*  
BEAUNE - FRANCE

**DAMY**  
MEURSAULT - FRANCE

**maury&fils**  
TONNELIERS A BORDEAUX DEPUIS 1893

  
CANADELL

EGGINOX

  
**DRUNK  
TURTLE**

*Vin  
& Terre*

  
concrete dreams

  
Master  
Coopers

WINEGLOBE

  
SCHNECKENLEITNER  
AUSTRIA

EUROPEAN  
HUNGARY  
COOPERS

*A commitment to quality and customer service*



[www.bouchardcooperages.com](http://www.bouchardcooperages.com) • (707) 257-3582 • [sales@bouchardcooperages.com](mailto:sales@bouchardcooperages.com)

