



BOUCHARD COOPERAGES
NEW ZEALAND LTD.

OAK PORTFOLIO 2024 NEW ZEALAND

Oak Barrels • Casks & Ovals • Oak Alternatives



French Oak • Hungarian Oak • Austrian Oak • American Oak

A commitment to quality and customer service

TONNELLERIE
Billon
BEAUNE - FRANCE

DAMY
MEURSAULT - FRANCE



EUROPEAN
HUNGARY
COOPERS

S
SCHNECKENLEITNER
AUSTRIA

CANADELL

WWW.BOUCHARDCOOPERAGES.COM

Lynnette Hudson - Sales & Technical Info
Erin Shull - Accounts & Logistics

021 650 197
027 420 5164

lynnette@bouchardcooperages.com
erin@bouchardcooperages.com



Tonnellerie BEL AIR



HISTORY

Tonnellerie Bel Air was created in 2000 by several famous French wine producers, and is located in the prestigious region of Bordeaux. As modern winemakers look for barrels that show elegance and respect, and perform consistently every year, Bel Air sought to develop a unique wood selection method to achieve just that.

TODAY

Tonnellerie Bel Air offers barrels based on the texture and tannin profile of the wood, rather than the tightness or size of the grain. The Directors at Bel Air continually taste the wood during the aging process in their yard to determine not only the structural category it belongs to, but also the ideal seasoning time, which changes each year depending on the weather.



Oak tasting to ensure tannin maturity and balance in the final blend.

It's a fascinating tasting process, quite similar to assessing young red wine, in that not only the flavours are evaluated, but also the texture and tannins of the wood on the palate.

Since 2009 Bel Air has been a part of the PEFC (Programme for the Endorsement of Forest Certification) which is the world's largest forest certification system that promotes sustainable forest management.

STYLISTICALLY

Bel Air barrels focus on the tannin structure and providing support and drive to the wine.

The barrels uplift fruit and perfume to allow the varietal to shine, without dominant oak or toast impact.



The cooperage location between the Aquitaine region and Bordeaux vineyards, was selected for the perfect seasoning conditions.



Benoit Valliere and Benoit Caron with the new Bel Air Demi-muid 40mm staves.

STRONG POINTS

- Bordeaux supplier of French Oak
 - Special barrel: Absolue
- Tastes wood to ensure consistency
- Stave yard located onsite
- Fire / Steam bent barrels
- Three structural categories:
 - Volupté, Rélévation, Élegance
- Offers French oak barrels and puncheons (225L – 600L)
- Bel Air barrels are used for all varietals provided the winemaker has specific goals in mind



NEW



600L Demi-Muid,
40mm Staves

- Blend of Bel Air premium selection French Oak
- Steam bent with a two hour Light Long toasting

		FRENCH OAK		BARREL OPTIONS			
Product	Qty	Early Order	Late Order				
Bordeaux Export (225L) Burgundy Export (228L) 27 mm staves, 6 galvanized hoops				1-10	1,054 €	1,084 €	Élégance Fine and delicate tannin structure, some softness on the palate and good length. The barrels are steam bent to remove any harsh tannins, and to promote fruit brightness and elegance. <i>Recommended for light whites and delicate reds.</i>
		11-40	1,044 €	1,074 €			
Bordeaux Export Thin Stave (225L) 22 mm staves, 6 galvanized hoops		41+	1,031 €	1,061 €			
Bordeaux Chateau Ferré (225L) 22 mm staves, 8 galvanized hoops Recessed heads, bar crossing head				1-10	1,101 €	1,131 €	Révélation Gives length and drive to the wine whilst providing background support and good tannin structure. Respectful of the fruit and the varietal characteristics, encourages perfume and lift on the nose. <i>Recommended for full bodied whites and reds.</i>
		11-40	1,091 €	1,121 €			
		41+	1,078 €	1,108 €			
300L Hogshead 27 mm staves, 8 galvanized hoops				1-10	1,260 €	1,290 €	Volupté More powerful staves to bring volume and structure, encourages lift in the mid palate, whilst still being respectful of the fruit and showing perfume on the nose. <i>Recommended for red varietals.</i>
		11-40	1,248 €	1,278 €			
		41+	1,233 €	1,263 €			
400L Puncheon 27 mm staves, 8 galvanized hoops				1-10	1,509 €	1,539 €	Absolue Special selection of forests to combine power, finesse and elegance. Suited to long ageing, produced in small quantities.
		11-40	1,486 €	1,516 €			
		41+	1,465 €	1,495 €			
500L Puncheon 27 mm staves, 8 galvanized hoops				1-10	1,690 €	1,720 €	
		11-40	1,663 €	1,693 €			
		41+	1,587 €	1,617 €			
600L 27 mm staves, 36 mm head 8 galvanized hoops				1-10	2,345 €	2,375 €	
1/2 Muid 40 mm staves, 40 mm head 10 galvanized hoops				1-10	2,973 €	3,003 €	
TOAST LEVELS							
■ Light ■ Medium ■ Medium Long ■ Medium Plus				225L/22mm	+180 €		

- All custom orders must be confirmed no later than 1 October.
- All prices are listed in Euros (€) and include transport, duty and customs to our warehouse in Christchurch.
- For North Island and other delivery locations, please enquire. The prices do not include GST, which will be added separately to your invoice.
- Free winery delivery and price discounts are available for full container purchases.
- For Bordeaux Chateau Tradition or Burgundy Tradition, please contact us for availability and pricing.
- Black Hoops +35 € per 225L - 228L, for larger sizes please enquire.



TONNELLERIE

Billon

BEAUNE - FRANCE

Tonnellerie
BILLON

1
FRANCE

HISTORY

Tonnellerie Billon was created in 1947 by Gaston Billon, is located in Beaune and produces premium traditional forest origin barrels, puncheons and casks (225L - 820L) sourced from different French forests.

TODAY

Tonnellerie Billon is managed by Vincent Damy, who was awarded the prestigious "Meilleur Ouvrier de France" in 2007. Tonnellerie Billon along with sister company Les Tonnelleries de Bourgogne, or translated "The Cooperages of Burgundy", one of the few suppliers still able to offer oak selection by forest origin.



Vincent DAMY, Billon manager and 2007 meilleur ouvrier de France.

Since 1997 barrels produced at Billon are CTB certified (fûts de traditions Française-traditional French barrels).

This unique label ensures a high quality barrel's traceability, drying, technical features and respect for tradition.

Tonnellerie Billon is part of the PEFC (Programme for the Endorsement of Forest Certification) which is the world's largest forest certification system that promotes sustainable forest management.

STYLISTICALLY

TONNELLERIE
Billon
BEAUNE - FRANCE

Subtil



Billon Subtil process.

Billon barrels are most well known for respecting the wine and being true to the varietal by showcasing the fruit on the nose and palate as well as offering tremendous length and enhanced minerality.

STRONG POINTS

- Forest origin and special barrels
 - Special barrels: Select and Richelieu
- Partnered with stave mill in the Jura region of France:
 - Merrains du Jura
- Independently owned and part of Les Tonnelleries de Bourgogne
- Fire bent or steam bent and fire toasted barrels
- Offers French acacia barrels
- Offers French oak barrels, puncheons and casks (225L - 820L)



Merrains du Jura



Billon Chauffe 180 minute Light Long Toast.

180
TONNELLERIE BILLON
CHAUFFE
180 min lightlong toast

SUBTIL
Optional pre-toasting technique

Côte d'Or
100% Burgundian Oak

2024 BILLON
New Zealand Barrel Prices

Billon and Damy barrels can be combined for volume price discounts.

Product	Qty	FRENCH OAK (24 MONTH AIR DRY)		FRENCH ACACIA (24 MONTH AIR DRY)	EASTERN EUROPEAN (24 MONTH AIR DRY)
		Early Order (by October 1)	Late Order	All Season	All Season
Bordeaux Export (225L)	1-10	978 €	1,008 €	897 €	872 €
Burgundy Export (228L)	11-30	966 €	996 €	888 €	863 €
25/27 mm staves, 6/8 galvanized hoops	31-67	956 €	986 €	879 €	854 €
	68-1C	944 €	974 €	875 €	850 €
300L Puncheon	1-10	1,152 €	1,182 €	1,066 €	1,059 €
	11-30	1,140 €	1,170 €	1,055 €	1,048 €
25/27 mm staves, 6/8 galvanized hoops	31-50	1,130 €	1,160 €	1,045 €	1,037 €
	51-1C	1,119 €	1,149 €	1,039 €	1,032 €
500L Puncheon	1-5	1,679 €	1,709 €	1,611 €	1,600 €
	6-15	1,662 €	1,692 €	1,595 €	1,584 €
30/32 mm staves, 8 galvanized hoops	16-25	1,645 €	1,675 €	1,579 €	1,568 €
	26-1C	1,635 €	1,665 €	1,571 €	1,560 €

SUBTIL

A proprietary pre-toasting technique unique to Tonnellerie Billon that aims to remove the harsher tannins and organoleptic material from the wood in order to have faster integration and a more subtle impact of the oak and toast. This technique maintains Billon's signature long finish and lift on the palate.

Select

Special selection of Extra Tight Grain from a blend of French forests, minimum of 30 months air dry, intended for longer aging.

Richelieu

A unique blend of oak from small micro climates within three of the finest forests in France. One forest contributes a noted minerality, another imparts structure, texture and spice, while the third brings softness, freshness and elegance. Its proprietary toasting was developed specifically for bolder red varietals and blends. Minimum of 3 year air-dried staves, and 4 year air-dried heads.

Côte d'Or

Only three year air dry oak from Burgundy's Côte D'or department is used to craft this barrel. Therefore 100% Côte D'Or Burgundian oak coupled with the *Subtil steam bending process and different choice of toasts caters to an elegant respectful Burgundian barrel for pinot noir and chardonnay.

225/228L	300L	500L	225/228L	300L	500L	225/228L	300L	500L	228L	+60 €
+15 €	+18 €	+20 €	+93 €	+109 €	+155 €	+81 €	+94 €	+133 €		

BARREL CASKS (EARLY ORDER)						FOREST ORIGIN	TOAST LEVELS
Product	600L	700L	820L				
32 mm staves, 8 galvanized hoops	1,871 €	2,224 €	2,487 €			Allier	Light
45 mm staves, 8 galvanized hoops	2,399 €	3,076 €	3,182 €			Vosges	Light Long
						Nevers	Medium
						Jura	Medium Long
						French Acacia	Medium Plus
						Chatillon	Heavy
						Eastern Europe	
BARREL OPTIONS							
Name	225-228L	300-500L	600-820L				
Chauffe 180 (Light Long 180 minute toast)	+150 €	+150 €	+150 €				
Head Toasting	+10 €	+14 €	+21 €				
3 Year Air Dry (All forests)	+22 €	+24 €	+52 €				
4 Year Air-Dry (Allier, Jura, Vosges)	+47 €	-	-				
5 Year Air-Dry (Very Limited Availability)	+57 €	-	-				
Black Hoops	+22 €	+57 €	-				
							CHAUFFE 180
							
							+150 €

* Exclusive forest origins such as Tronçais, Bertranges, Jupilles and Citeaux are available for an additional charge.

- All custom orders must be confirmed by 1 October. Stock barrels available at late order price.
- All prices are listed in Euros (€) and include duty, customs, and transport to our warehouse in Christchurch or Napier. The prices do not include GST, which will be added separately to your invoice.
- Free winery delivery and price discounts are available for full container purchases.
- Other available sizes include 350L and 400L.

5

WWW.BOUCHARDCOOPERAGES.COM

TONNELLERIE
Billon
BEAUNE • FRANCE

Lynnette Hudson - Sales & Technical Info

021 650 197

lynnette@bouchardcooperages.com



HISTORY

Tonnellerie Damy is a third generation cooperage located in Meursault, Burgundy that was founded in 1946 by M. Roger Damy and produces premium traditional forest origin barrels, puncheons and casks (225 L - 860 L) sourced from different French forests.

TODAY

Tonnellerie Damy is now managed by Jérôme Damy who, like his father Jacques Damy in 1976, was awarded the Meilleur Ouvrier de France award in 2007.

Tonnellerie Damy along with sister company Tonnellerie Billon form Les Tonnelleries de Bourgogne, or translated "The Cooperages of Burgundy", one of the few suppliers still able to offer oak selection by forest origin.



Jérôme Damy, Damy manager and 2007 meilleur ouvrier de France.

Since 1997 barrels produced at Damy are CTB certified (fûts de traditions Française - traditional French barrels) which is a unique label, ensuring a high quality barrel's traceability, drying, technical features and respect for tradition.

Tonnellerie Damy is part of the PEFC (Program for the Endorsement of Forest Certification) which is the world's largest forest certification system that promotes sustainable forest management.

Tonnellerie Damy is one of the most renowned Burgundian Cooperages. The barrels are synonymous with the world's greatest Chardonnays and Pinots and are featured in many Côtes de Beaune and Nuits domaines. The distinctive and delectable house style is the reason you will find Damy barrels in many wineries around the world.

STYLISTICALLY

Damy barrels have traditionally offered a stunning ability to soften tannins and provide a creamy, rounded mid-palate, while its lighter more respectful toasting enhances vineyard terroir. Both styles of toasting support and enhance fruit sweetness to complement both white and red wines, and both are available in a variety of forest origins.



Noisette color of the inside of a DAMY barrel after the 2 hour super light long "Imperial" toast.



Damy Imperial barrel.

STRONG POINTS

- Forest origin and special barrels
 - Special barrels: Imperial, Exclusive, Rouge and R2
- Partnered with stave mill in the Jura region of France:
 - Merrains du Jura
- Independently owned and part of Les Tonnelleries de Bourgogne
- Fire bent and fire toasted barrels
- Offers French oak barrels, puncheons and casks (225L - 860L)



Merrains Jura



IMPERIAL

Three forest blend, seasoned 36 months, with two hour light long proprietary toast

Délicat

Optional barrel softening technique

- Light Long Plus Plus Toast

2024 DAMY
New Zealand Barrel Prices

Billon and Damy barrels can be combined for volume price discounts.

Product	Qty	FRENCH OAK (24 MONTH AIR DRY)		AMERICAN OAK (36 MONTH AIR DRY)	EASTERN EUROPEAN (24 MONTH AIR DRY)
		Early Order (by October 1)	Late Order		
Bordeaux Export (225L)	1-10	978 €	1,008 €	718 €	872 €
Burgundy Export (228L)	11-30	966 €	996 €	711 €	863 €
25/27 mm staves, 6/8 galvanized hoops	31-67 68-1C	956 € 944 €	986 € 974 €	704 € 700 €	854 € 850 €
300L Puncheon	1-10	1,152 €	1,182 €	848 €	1,059 €
25/27 mm staves, 8 galvanized hoops	11-30 31-50 51-1C	1,140 € 1,130 € 1,119 €	1,170 € 1,160 € 1,149 €	839 € 831 € 826 €	1,048 € 1,037 € 1,032 €
500L Puncheon	1-5	1,679 €	1,709 €	1,207 €	1,600 €
30/32 mm staves, 8 galvanized hoops	6-15 16-25 26-1C	1,662 € 1,645 € 1,635 €	1,692 € 1,675 € 1,665 €	1,195 € 1,183 € 1,177 €	1,584 € 1,568 € 1,560 €



A blend of premium oak from the Vosges, Allier and Jura regions of France with a proprietary 2 hour light long toast only on small embers that gives a very light noisette colored toast to the barrel. Aimed to offer very nuanced oak characteristics and lift the terroir and fruit components of your wine.

Imperial



Limited quantities. Created especially for powerful, grand-cru style wines. Extra tight grain from a melange of the finest French forests. Optimal seasoning and proprietary toast. Brings a restrained, fruit-forward elegance.

Exclusive



Specifically developed to honor the character of Rhône varietals (red and white). Tight grain French oak from a premier French forest and single supplier. 36 months seasoning. Proprietary Toast. Reveals fruity notes and sweetness on the nose; silky smooth tannins on the palate with volume and freshness.

Estrella 45*



A hand-selected blend of extra tight grain French oak all sourced from one long term respected supplier. 36 months seasoning. Proprietary Toast. A stronger end toast is used on the R2 to help develop structure in bolder red wines.

Rouge (R or R2)

Imperial		Exclusive			Estrella 45*			Rouge (R or R2)		
225/228L	500/600L	225/228L	300L	500L	225/228L	300L	500L	225/228L	300L	500L
+150 €	+150 €	+93 €	+109 €	+155 €	+22 €	+24 €	+24 €	+62 €	+72 €	+103 €

BARREL CASKS (EARLY ORDER)				FOREST ORIGIN		TOAST LEVELS	
Product	600L	700L	860L	Allier Vosges Nevers Jura Chatillon American (PA)	Light Light Long Light Long Plus Medium Medium Long Medium Plus Heavy		
32 mm staves, 8 galvanized hoops	1,871 €	2,224 €	2,610 €				
45 mm staves, 8 galvanized hoops	2,399 €	3,076 €	3,253 €				
BARREL OPTIONS						DÉLICAT	
Name	225/228L	300-500L	600-860L			<p>A proprietary barrel finishing technique that softens the initial presence of oak and elevates the integration and harmony between the fruit, oak and toast.</p>	
DAMY Délicat (Barrel softening technique)	+15 €	+18 €	+20 €				
Head Toasting (No charge for American Oak)	+10 €	+14 €	+21 €				
3 Year Air Dry (All forests)	+22 €	+24 €	+52 €				
4 Year Air-Dry (Allier, Jura, Vosges)	+47 €	-	-				
5 Year Air-Dry (Very Limited Availability)	+57 €	-	-				
Black Hoops	+22 €	+57 €	-				

* Exclusive forest origins such as Tronçais, Bertranges, Jupilles and Citeaux are available for an additional charge.

- All custom orders must be confirmed by 1 October. Stock barrels available at late order price.
- All prices are listed in Euros (€) and include duty, customs, and transport to our warehouse in Christchurch or Napier. The prices do not include GST, which will be added separately to your invoice.
- Free winery delivery and price discounts are available for full container purchases.
- Other available sizes include 350L and 400L.



Master Cooper Kristof selecting oak trees in the Tokay forest for stave production.

European Coopers Hungary produces premium Hungarian oak barrels that are everything you would expect from a quality-driven artisan cooper.

Kristof and his team control the entire process in house, from sourcing and selecting 100% Hungarian logs from Hungary's best forests in the Zemplen and Mecsek hills, to seasoning the staves, and producing and finishing the barrels.

STYLISTICALLY

European Coopers Hungary barrels are either coopered exclusively with oak from the forests of Tokay, Mecsek or a blend of both forests.

Tokay offers elegance and a fine tannin profile while Mecsek offers phenolic richness and palate weight.

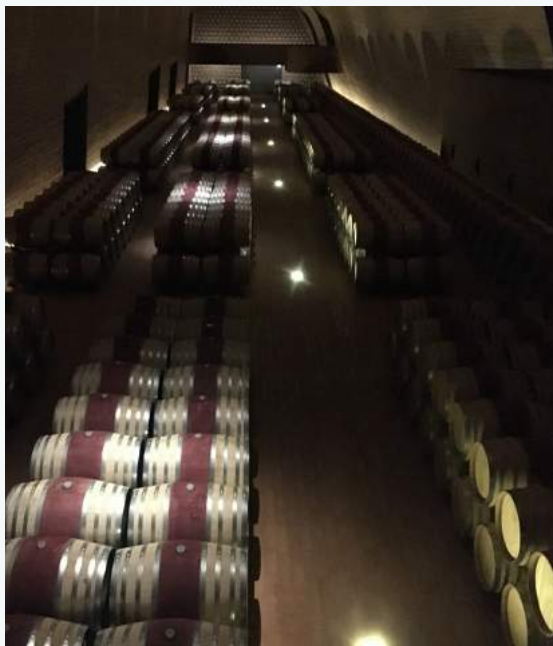

Rows of Antinori European Coopers Hungary barrels being used to age their Tignanello Super Tuscan.

HISTORY

European Coopers Hungary is a premium Hungarian cooperage that produces Hungarian oak barrels (225 L - 500 L). The cooperage is located two hours south of Budapest and is proud of remaining independent since its establishment in 1997. With over forty years of experience, Master Cooper Kristof Flodung has been at the heart of European Coopers Hungary since day one in 1997.

TODAY

European Coopers Hungary was co-founded by three respected Italian winemaking families that were searching for premium Hungarian oak for their wines. Vincent Bouchard is involved as a consultant on toasting and barrel technicalities.

After Hungary opened its markets and becoming part of the EU in 2004, there has been a resurgence in demand for Hungarian oak on the international wine scene.



Convection toasting being used for the "Radiant White and Red" toasts.

STRONG POINTS

- Hungarian oak barrels and a special barrel
 - Special barrel: Kristof
 - Special Toast: Radiant White and Radiant Red
- The sourcing, cutting, splitting and ageing of the wood and coopering of the barrel is all done internally
- Independently owned cooperage
- Only 3-Year air dried oak
- Fire bent and fire and convection toasted barrels
- European Coopers Hungary purchases logs from parts of the Mecsek and Tokay forests that have the FSC certificate and the Natura 2000 certificate which both promote sustainable forest management
- Offers Hungarian oak barrels and puncheons (225L - 500L)



2024 EUROPEAN COOPERS
New Zealand Barrel Prices

Product	Qty	HUNGARIAN OAK (36 MONTHS AIR DRY)	
Bordeaux Export (225L)	1-10	756 €	 <p>+50 €</p> <p>Named for Master Cooper Kristof Flodung, the Kristof barrel is a blend of extra tight grain from the finest selections of Mecsek and Tokay. The staves are aged for a minimum of 3 years and the heads 4-5 years. All three toasting options are finished with a proprietary process developed for deeper penetration, subtlety and elegance.</p> <p>(Available from 225L & 228L - 500L)</p>
Burgundy Export (228L)	11-30	725 €	
25/27 mm staves, 6/8 galvanized hoops	31-67	694 €	
	68-1C	659 €	
300L Hogshead	1-10	883 €	
	11-30	846 €	
	25/27 mm staves, 6/8 galvanized hoops	31-50	
400L Puncheon	51-1C	764 €	
	1-8	961 €	
	9-16	919 €	
27 mm staves, 8 galvanized hoops	17-25	877 €	
	26-1C	841 €	
	500L Puncheon	1-8	1,278 €
9-16		1,206 €	
27 mm staves, 8 galvanized hoops		17-25	1,132 €
	26-1C	1,074 €	

OAK SELECTIONS				SPECIAL SIZES	
----------------	--	--	--	---------------	--

Name	Forest Origin	Grain Width	Air Dry	Size	Price
Tokay	Tokay Mountains	< 1.5 mm	36 months		
Tokay Blend	2/3 Tokay, 1/3 Mecsek	1.5-2.0 mm	36 months	60L	390 €
Hungarian	Blend of Tokay and Mecsek	1.5-3.0mm	36 months	110L	473 €
Mecsek Blend	1/3 Tokay, 2/3 Mecsek	2.0-3.0 mm	36 months	600L	1,600 €
Mecsek	Mecsek Hills	2.0-3.0 mm	36 months		

BARREL OPTIONS			TOAST LEVELS	
----------------	--	--	--------------	--

Name	225/228L	300-500L	Fire Toast	Convection Toast
Head Toasting	+10 €	+13 €	<ul style="list-style-type: none"> ■ Light ■ Light Long ■ Medium ■ Medium Long ■ Medium Plus ■ Heavy 	<ul style="list-style-type: none"> ■ Radiant White ■ Radiant Red
Tokay Oak (extra fine grain)	+26 €	+45€		
2/3 Tokay Oak Selection	+13 €	+22 €		
Kristof	+50 €	+50 €		

- All custom orders must be confirmed by 1 October.
- All prices are listed in Euros (€) and include duty, customs, and transport to our Christchurch warehouse.
- All barrel prices are exclusive of GST. For other delivery locations, please inquire.



SCHNECKENLEITNER
AUSTRIA

Fassbinderie SCHNECKENLEITNER



HISTORY

Fassbinderie Schneckenleitner is a fifth generation Austrian artisan family-run cooperage that is located in Waidhofen/Ybbs, located in the foothills of the Austrian Alps.

The cooperage was founded in 1628, and the Schneckenleitner family has been at the helm of the cooperage since 1880. Schneckenleitner produces premium quality large format vessels, and they are best known for their ovals and casks or rounds as they call them. The oak for these ovals and rounds (10 HL - 60 HL) are either sourced 100% in Austria or are made from a mix of Eastern European oak.

TODAY

Fassbinderie Schneckenleitner is managed by Paul Schneckenleitner, who is a fifth generation Master Cooper from the Schneckenleitner family. Before managing the family cooperage, Paul gained invaluable experience by working in several Burgundy and Cognac based cooperages.



Paul Schneckenleitner inspecting staves for large format production.

Schneckenleitner buys entire oak and acacia logs from forests they have been working with for generations. The logs are brought to their production site and the splitting, preparing and air drying of the wood is done on site. They cooper vessels made from tight grain Weidling Oak and Acacia that is sourced from forests in southern Austria.

STYLISTICALLY

Schneckenleitner has built their reputation on the production of their large format ovals and puncheons which are found in many of Europe's finest cellars. Because of the large format, the incredibly long and low toast, and significantly long air-drying time results in extremely low impact ovals, rounds and puncheons that respect the wine's fruit, freshness and minerality, while allowing for some natural micro-oxidation to occur. Their large format vessels work both on white and red wines.



New Schneckenleitner cooperage completed in 2022.



Freshly planed Oval.



15 HL round cask destined for Oddero in Piedmonte.



25 HL oval casks destined for South Africa.



45 mm thick stave 500L puncheon in Chablis.

STRONG POINTS

- Independently family-owned artisanal cooper where all important steps are still done by hand
- Reputation built on 10HL - 60HL+ Ovals and Rounds
- Also coopers 45 mm thick stave puncheons and conicals
- Directly buys and handles logs at stave mill located at the cooperage
- Air drying of oak is done on site
- Selection of 100% Austrian Oak and Austrian Acacia
- Long air drying time for wood preparation
- House toasts are the: AOC (Austrian Oak Complex) and AOE (Austrian Oak Elegance)

2024 SCHNECKENLEITNER
New Zealand Cask Prices

CASKS

Product - Weidling Oak	500L	600L	700L	800L
29 mm thick staves	2,295 €	2,595 €	2,935 €	3,275 €
45 mm thick staves	2,835 €	3,200 €	3,565 €	3,910 €

ROUNDS

Product UNIT	Litres (L)	Bilge Height (cm)	Bilge Width (cm)	Head Height (cm)	Head Width (cm)	Weight (kg)	Stave Length (cm)	Stave Thickness (mm)	Weidling Oak
10HL	1,000	125	125	109	109	317	130	47	10,925 €
13HL	1,300	136	136	117	117	396	139	47	12,455 €
15HL	1,500	140	140	123	123	467	150	50	13,450 €
20HL	2,000	154	154	136	136	557	161	52	15,940 €
25HL	2,500	167	167	147	147	696	173	57	18,485 €
30HL	3,000	177	177	156	156	835	183	60	20,945 €

OVALS

10HL	1,000	147	106	135	96	317	130	48	10,830 €
13HL	1,300	155	110	143	100	396	135	48	12,005 €
15HL	1,500	170	119	158	109	476	141	50	13,310 €
20HL	2,000	189	129	175	118	557	153	53	15,840 €
25HL	2,500	204	143	189	131	696	158	55	18,345 €
30HL	3,000	214	148	198	136	835	172	57	20,815 €

OVAL WITH STANDARD ACCESSORIES

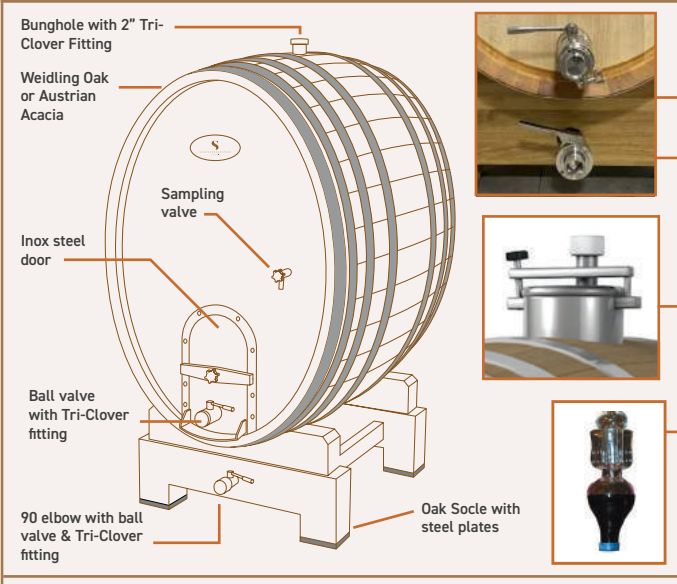

- All custom orders must be confirmed by 1 October. Exceptionally high demand and limited availability. Please place your order early.
- Additional sizes up to 60HL available upon request.
- All prices are listed in Euros (€) and include duty, customs and transport to our Christchurch warehouse.
- Your invoice will be in \$NZD based on the exchange rate at the date of invoice. 30% deposit due at the order confirmation for all Rounds & Ovals, with 70% balance due before delivery to the winery.
- On average, the natural air drying process seasons about 10 mm of the stave's thickness per year.
- Above prices do not include GST.

CASK & OVAL OPTIONS

500L - 800L OPTIONS	
Outlet Connection 1" with Cap	125 €
2" Tri Clover racking ball valve on head	285 €
90 degree elbow drain with 2" Tri Clover butterfly valve	640 €
Wooden Socle	790 €
10HL - 60HL OPTIONS	
Top Manhole with TC fitting and pressure compensating valve	Varies on size
Painted Hoops	Varies on size
Cooling Plate	Varies on size
Colmatore	188 €
Laser Engraving	390 €
Thermometer with immersion sleeve	390 €
Thermowell	165 €
1x Oak Support Bar on Head	Varies on size
2x Oak Support Bar on Head	

OAK SELECTIONS

Weidling Oak Selection of fine grain oak from a forest in Southern Austria.
TOAST LEVELS
AOE Austrian Oak Elegance which is a slightly softer, more transparent and showcases more fruit and removes more tannin from the wood.
AOC Austrian Oak Complex which is slightly bolder and more structural on the palette.
CASKS 500/800L
AOE-, AOE, AOE+ AOC-, AOC, AOC+

HISTORY

Merrandier Canadell was established in 1940 by Lauriano Canadell in Trie-sur-Baïse in France's Hautes Pyrénées department. For four generations and over sixty years, Canadell has been providing staves of the highest quality to the largest and most prestigious cooperages around the world for barrel making. In 2000 Canadell launched their own line of fine oak alternative products for winemaking which include Chips, Dominoes and Staves.



Fred and Jacques Canadell in front of a French oak log destined for stave production.

TODAY

Canadell is currently managed by Jacques Canadell and his son Frédéric. Canadell is one of the oldest and largest customers of France's Office National des Forêts (ONF).



French oak tree in the Tronçais forest of France.

With two stave mills in France and connections to France's most prestigious forests, Canadell uses strict proprietary toasting regimens to carefully craft a complete line of oak alternatives.

Canadell oversees the entire manufacturing process of its oak alternative products for full traceability, from selecting trees in the forest to seasoning, splitting, air drying, toasting and the final packaging of the product. Canadell is part of the PEFC (Programme for the Endorsement of Forest Certification) which is the world's largest forest certification system that promotes sustainable forest management.

STYLISTICALLY

The Canadell product line includes chips for use during fermentation and post ferment aging, to dominoes and staves, which best showcase the qualities of French oak and show characters remarkably similar to barrel aging. Canadell bridges the gap between barrels and oak alternatives.



Oak chips



French oak dominoes



Barrel inserts through the bung



Fire toasted French oak staves











French oak staves

STRONG POINTS

- Company historically is a merrandier, ensuring control of its oak alternative product line from the source: the oak tree
- Complete in house integration from when oak is cut to packaging
- Independently owned
- Large selection of alternative products and toast levels
- Fire and Convection Toasted Staves
- Chips
- Dominoes



FRENCH OAK CHIPS		QTY	PER BAG	PER KG		
French Oak MINI-CHIPS 10 kg per bag 60 bags per pallet		Toasted (L, M, M+)	1-20 Bags 21-50 Bags	\$175.00 \$161.00	\$17.50 \$16.10	
		Toasted (L, M, M+)	1-20 Bags 21-50 Bags	\$175.00 \$161.00	\$17.50 \$16.10	
French Oak Chips HIGH IMPACT		Toasted (M, M+)	1-20 Bags 21-50 Bags	\$175.00 \$161.00	\$17.50 \$16.10	
10 kg per bag 60 bags per pallet		Toasted (L, M, M+)	1-20 Bags 21-50 Bags	\$175.00 \$161.00	\$17.50 \$16.10	
FRENCH OAK DOMINOES		QTY	PER BAG	PER KG		
French Oak Dominoes 41.2 cm ² each 10 kg per bag 60 bags per pallet		Toasted (L, M, M+)	1-20 Bags 21-50 Bags	\$315.00 \$295.00	\$31.50 \$29.50	
		Toasted (L, M, M+)	1-20 Bags 21-50 Bags	\$315.00 \$295.00	\$31.50 \$29.50	
FRENCH OAK TANK STAVES		QTY	PER PACKET	PER STAVE		
Tank Staves		Toasted (L, M, M+)	1-20 Bags 21-50 Bags	\$390.00 \$360.00	\$7.80 \$7.20	
		Long Toast	1-20 Bags 21-50 Bags	\$420.00 \$390.00	\$8.40 \$7.80	
		Fire Toasted (M, M+)	1-20 Bags 21-50 Bags	\$585.00 \$540.00	\$11.70 \$10.80	
		95 x 5 x 0.7 cm 1,090 cm ² 50 staves per fan 114 bags per pallet	Toasted (L, M, M+)	1-20 Bags 21-50 Bags	\$390.00 \$360.00	\$7.80 \$7.20
		Long Toast	1-20 Bags 21-50 Bags	\$420.00 \$390.00	\$8.40 \$7.80	
		Fire Toasted (M, M+)	1-20 Bags 21-50 Bags	\$585.00 \$540.00	\$11.70 \$10.80	

-  Please order these products, and any other customer orders, no later than 1 October to assure delivery.
-  All Canadell products are sold and invoiced in \$NZD, and are sold per bag or per packet.
-  The prices listed above are DDP Cromwell warehouse and are exclusive of GST. Multiple container discounts are available.
-  For further information on trials, specifications or dosages, please contact Roberta at Bouchard Cooperages.
-  Samples available.



FUTAIE GROWTH MAP

Oak Tree Categories and Life Stages

*This custom graphic is property of Bouchard Cooperages.

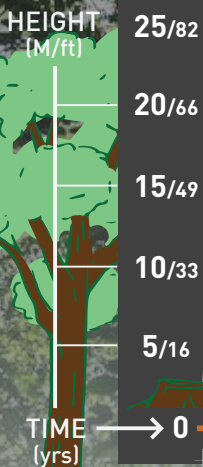

OAK CATEGORY	SEMIS	FOURRE	GAULIS	PERCHIS	JEUNE FUTAIE	FUTAIE ADULTE	FUTAIE ADULTE
AVERAGE DENSITY (TREES/HA)	1 MILLION	600,000	60,000	30,000	400	250	120
SILVICULTURE OPERATION	CLEARANCES	THINNING/DIVISIONS	CLEANING	THINNING	THINNING	REGENERATION CUTS	RISK THAT TREE BEGINS TO DIE FROM THE INSIDE

Suppression of competing vegetation while preserving the diversity of forest species.

Progressive widening of space between trees for better growth and allowing access for maintenance work, sanitary surveillance, and protection of the environment during operations.

Progressive thinning of trees to ensure better growth and mixing of different species.

Regular cuts for tree improvement and the harvesting of diseased, struggling, or dead trees.

Progressive harvesting of mature trees that favors the natural planting and renewal of the mature tree stand.

Risk exists at the age of 200+ years that oak trees start to naturally die from the inside out.

FOREST ORIGINS

FRENCH FORESTS

1. **Jupilles/Bercé** 5,400 ha
2. **Bellême** 2,400 ha
3. **Blois** 2,800 ha
4. **Limousin** 568,000 ha
5. **Allier** 122,000 ha
6. **Tronçais** 10,500 ha
7. **Fontainebleau** 17,000 ha
8. **Nevers** 225,000 ha
9. **Bertranges** 10,000 ha
10. **Ardennes** 36,140 ha
11. **Chatillon** 9,000 ha
12. **Cîteaux** 13,284 ha
13. **Vosges** 280,000 ha
14. **Jura** 180,000 ha

*ha = generalized hectares of forest that includes other trees besides oak.

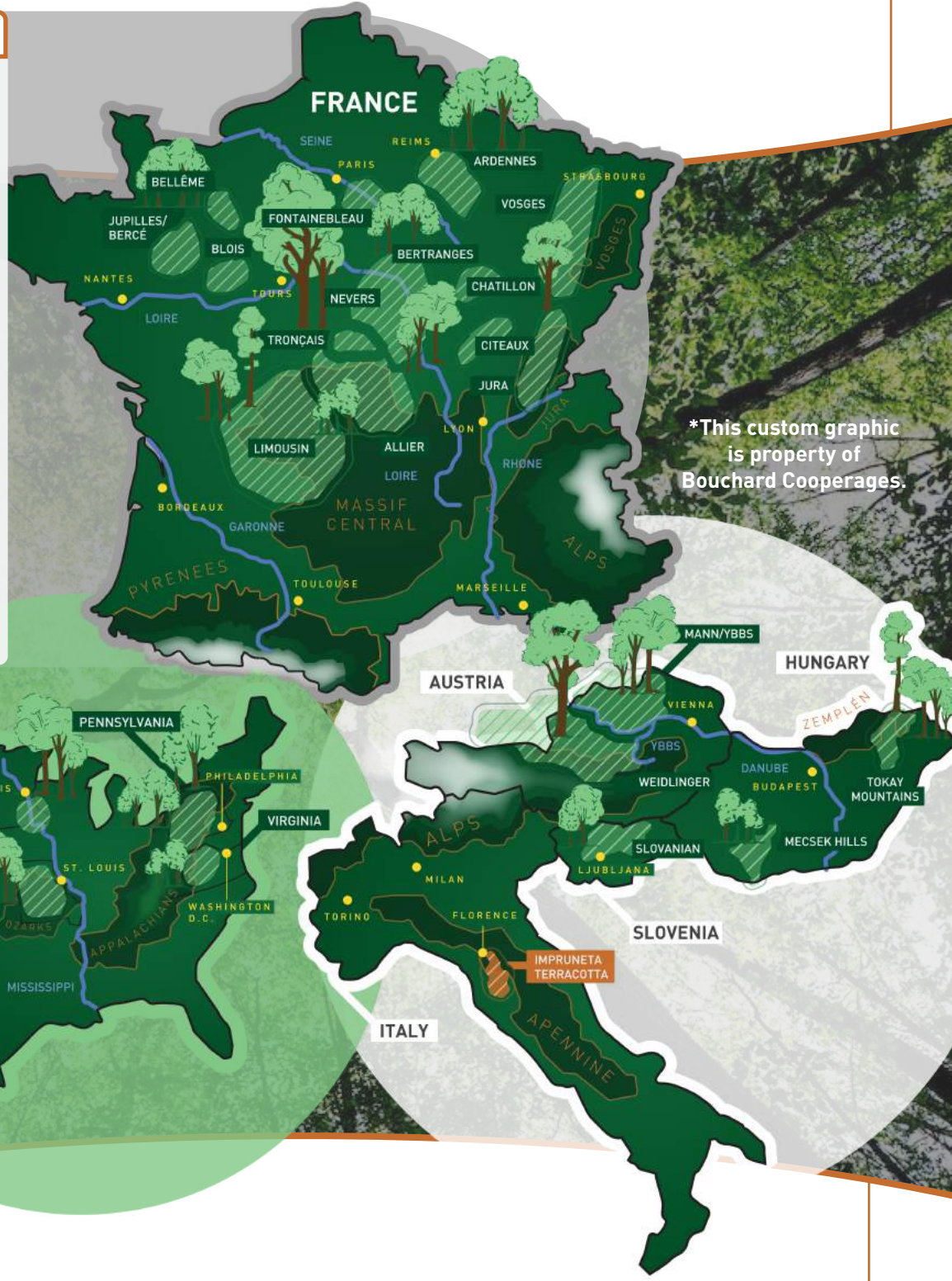

*This custom graphic is property of Bouchard Cooperages.



**BOUCHARD COOPERAGES
NEW ZEALAND LTD.**

Proudly Representing

OAK BARRELS • CASKS & OVALS • OAK ALTERNATIVES



TONNELLERIE
Billon
BEAUNE - FRANCE

DAMY
MEURSAULT - FRANCE

**EUROPEAN
HUNGARY
COOPERS**

S
SCHNECKENLEITNER
AUSTRIA

CANADELL

JARRES • EGGS • AMPHORAE



A commitment to quality and customer service

WWW.BOUCHARDCOOPERAGES.COM

Lynnette Hudson - Sales & Technical Info
Erin Shull - Accounts & Logistics

021 650 197
027 420 5164

lynnette@bouchardcooperages.com
erin@bouchardcooperages.com